

# AIR BRAKE SYSTEMS



[grower.com.tr](http://grower.com.tr)

**GROWER**<sup>®</sup>  
Air Brake Systems

1988 yılında Konya’da küçük bir atölyede başlayan bu üretim macerası, geçen her yıl içinde kendisini sürekli yenileyen, insana yatırıma, kalitenin sürekliliğine önem veren ve ürün yelpazesini geniş bir alana yayan AYBEY CONTA OTOMOTİV, Tır, Kamyon, Otobüs grubu araçlar için Hava Fren Kompresör Parçalarını GROWER markası ile üretmeye devam etmektedir.

Üretiminin büyük bir çoğunluğunu yurtdışında 30’dan fazla ülkeye ihraç eden GROWER yurtdışında oluşturduğu bayileri ve satış sonrası desteğiyle müşteri memnuniyetini en önemli görev sayarak ve her daim en iyi hizmeti sunmayı amaçlayarak, sektördeki 30 yıllık deneyimiyle ve GROWER markasıyla adından bahsedilir kaliteli bir firma profili çizmiştir.

Ürettiği her ürünün gerisinde güçlü markasıyla sektöründe yer alan GROWER, ileri teknoloji üretim araçları ve geniş makine parkuru ile kalitesinden ve yüksek verimliliğinden ödün vermeden daima yaratıcı ve yenilikçi düşünceler doğrultusunda sektör standartlarının yükselmesine katkıda bulunarak, müşteri beklentilerini en iyi şekilde karşılayarak OEM kalitesinde üretim yapan, tüm dünyanın tanıdığı güvenilir bir marka olmayı ana amaç edinmiştir ve bu yolda her zaman daha iyisi için çalışmaya devam ederek sektöründe en önde gelen firmalardan birisi olmuştur.

Our production adventure started in a small workshop in Konya in 1988, over the past years as AYBEY CONTA we constantly renew ourselves. We give great importance to investment in our expert staff, the continuity of increased quality and the product range to a wide area. We continue to produce Air Brake Compressor Parts for trucks and Bus groups under the brand GROWER.

Exporting the majority of our production line to more than 30 countries, GROWER has drawn a quality company profile that can be mentioned with its 30 years of experience in the sector. We believe that our customer satisfaction is the most important task and always aim to provide the best service for our official dealers and after sales support.

GROWER, which is in the sector with its strong brand behind every product it produces, with advanced technology production tools and wide machine park, without compromising its quality and high efficiency, always contributing to the rise of sector standards in line with creative and innovative thoughts, meeting customer expectations in the best way possible, producing in OEM quality. Grower aims to be a reliable brand that the world knows and it has always been one of the leading companies in its sector by continuing to work for the better.

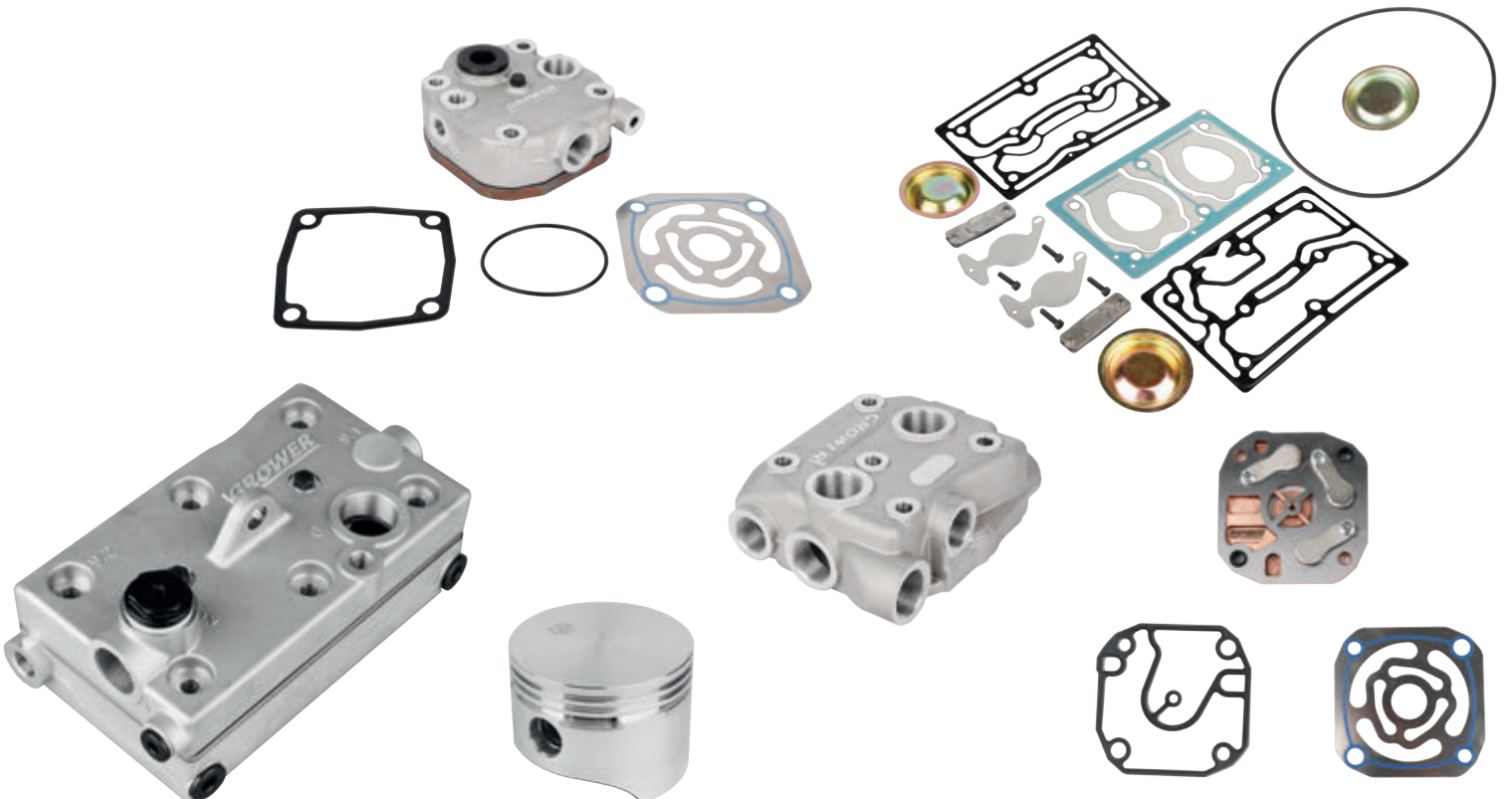



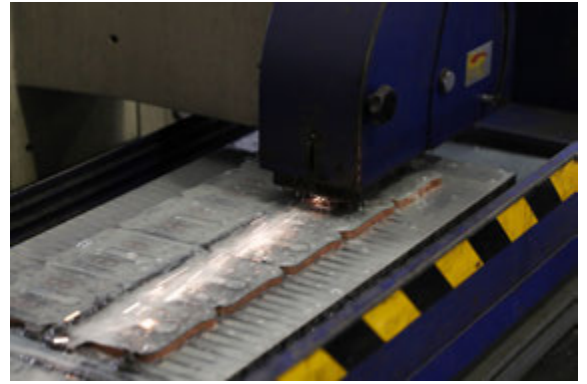







Kompresör Tamir Takımları  
Compressor Repair Kits

FORD

**GROWER**<sup>®</sup>  
Air Brake Compressor Repair Kits

COMPRESSOR APPLICATION	110-5006-000	FORD CARGO 4142-4142D 4142XD		
------------------------	--------------	------------------------------------	--	--



Silindir Kapak Komple  
Cylinder Head Complete

110-5006-050

Kompresör Conta Takımı  
Compressor Gasket Kit

110-5006-200



Kompresör Conta Takımı  
Compressor Gasket Kit

110-5006-201

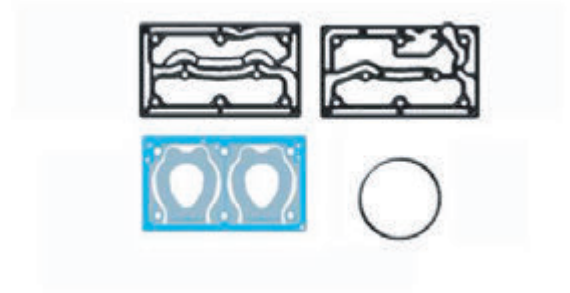

Kompresör Conta Takımı  
Compressor Gasket Kit

110-5006-210



Valf Takımı  
Valve Kit

630-085-107

**FORD**

COMPRESSOR APPLICATION	110-5006-000	FORD CARGO 4142-4142D 4142XD		
------------------------	--------------	------------------------------------	--	--

COMPRESSOR APPLICATION	110-5005-000	1838 T E5 - 2538 F 3238 C - 3238 S 3936 M - 3536 D	LK 4958 - K013739 - 7C46 2875 AD N
------------------------	--------------	--	------------------------------------

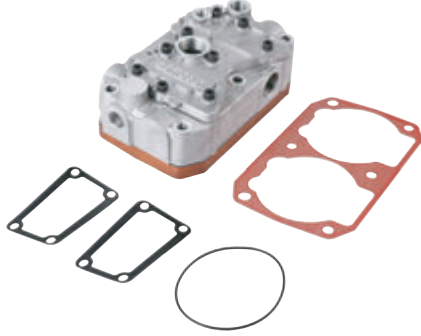

Silindir Kapak Komple  
Cylinder Head Complete

110-5005-050

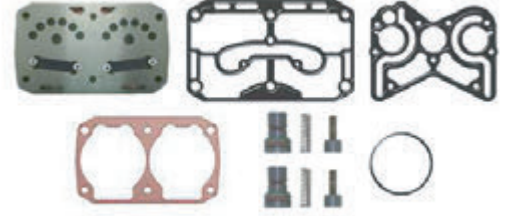

Kompresör Tamir Takımı  
Compressor Repair Kit

110-5005-090

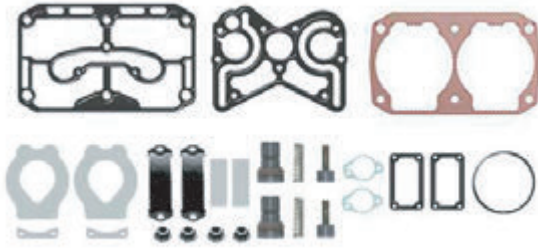

Kompresör Tamir Takımı  
Compressor Repair Kit

110-5005-100

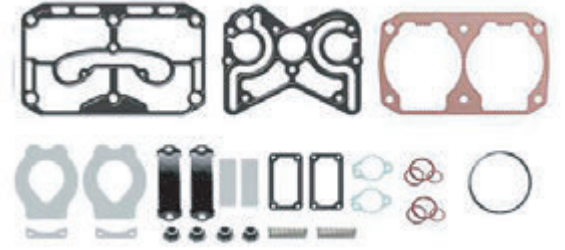

Kompresör Tamir Takımı  
Compressor Repair Kit

110-5005-110



Kompresör Conta Takımı  
Compressor Gasket Kit

110-5005-200

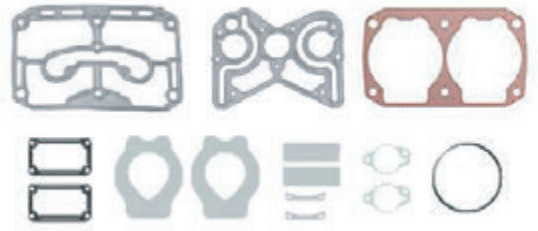

Kompresör Conta Takımı  
Compressor Gasket Kit

110-5005-201

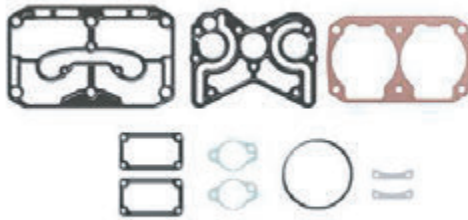

Kompresör Conta Takımı  
Compressor Gasket Kit

110-5005-210



Valf Takımı  
Valve Kit

630-086-101



## FORD

COMPRESSOR APPLICATION	110-5005-000	1838 T E5 - 2538 F 3238 C - 3238 S 3936 M - 3536 D	LK 4958 - K013739 - 7C46 2875 AD N
------------------------	--------------	--	------------------------------------



Subap Takımı  
Valve Kit

610-086-101

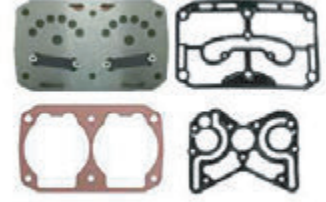

Kompresör Pleyt  
Compressor Plate  
1361262

570-086-104



Üst Kapak  
Cylinder Head

550-086-104

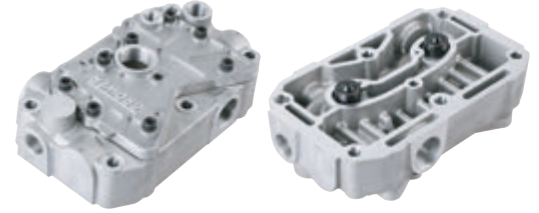

Üst Kapak  
Cylinder Head

550-086-105

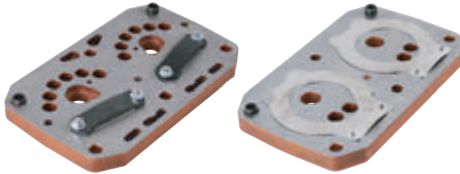

Kompresör Pleyt  
Compressor Plate

560-086-104



Piston

Piston	Ø86 mm 2.00 x 2.00 x 3.00 (STD)	230-086-101
	Ø86 mm 2.00 x 2.00 x 3.00 (0.25)	230-086-102
	Ø86 mm 2.00 x 2.00 x 3.00 (0.50)	230-086-103
	Ø86 mm 2.00 x 2.00 x 3.00 (0.75)	230-086-104
	Ø86 mm 2.00 x 2.00 x 3.00 (1.00)	230-086-105



Segman  
Ring

Ø86 mm 2.00 x 2.00 x 3.00 (STD)

231-086-101

Ø86 mm 2.00 x 2.00 x 3.00 (0.25)	231-086-102
Ø86 mm 2.00 x 2.00 x 3.00 (0.50)	231-086-103
Ø86 mm 2.00 x 2.00 x 3.00 (0.75)	231-086-104
Ø86 mm 2.00 x 2.00 x 3.00 (1.00)	231-086-105



Piston & Segman Set

Piston & Ring Set Ø86 mm 2.00 x 2.00 x 3.00 (STD)

233-086-101

42549147-SEB22547-SEB22548	
Ø86 mm 2.00 x 2.00 x 3.00 (0.25) Iveco: 42549148	233-086-102
Ø86 mm 2.00 x 2.00 x 3.00 (0.50)	233-086-103
Ø86 mm 2.00 x 2.00 x 3.00 (0.75)	233-086-104
Ø86 mm 2.00 x 2.00 x 3.00 (1.00)	233-086-105

COMPRESSOR APPLICATION	110-5004-000	1835 1838 3235	LK4958
------------------------	--------------	----------------------	--------

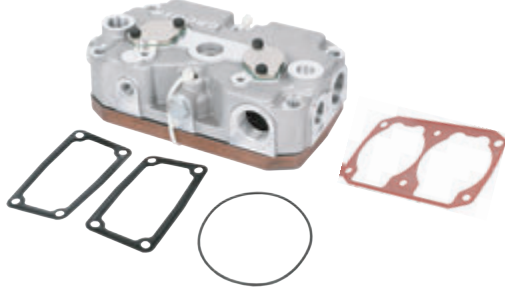

Silindir Kapak Komple  
Cylinder Head Complete

110-5004-050

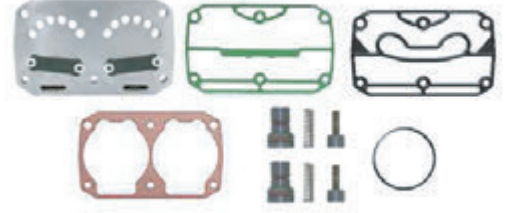

Kompresör Tamir Takımı  
Compressor Repair Kit

110-5004-090

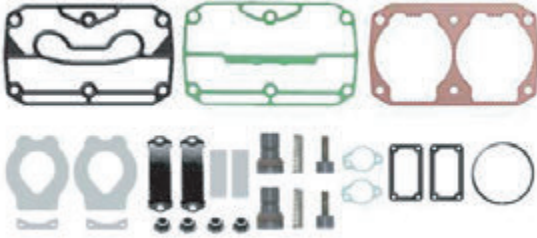

Kompresör Tamir Takımı  
Compressor Repair Kit  
SEB22549

110-5004-100

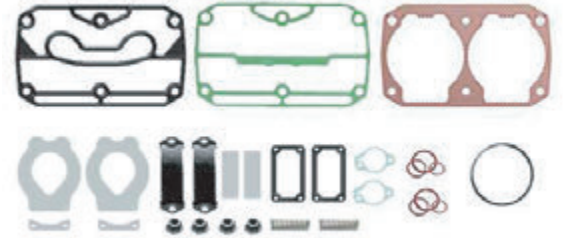

Kompresör Tamir Takımı  
Compressor Repair Kit  
1285856

110-5004-110

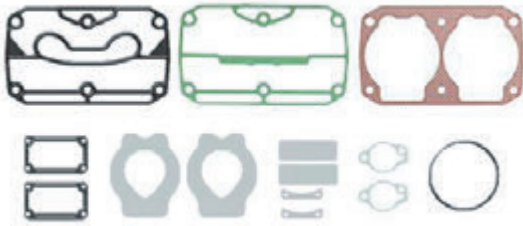

Kompresör Conta Takımı  
Compressor Gasket Kit

110-5004-200

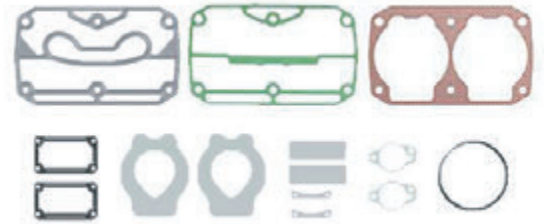

Kompresör Conta Takımı  
Compressor Gasket Kit

110-5004-201

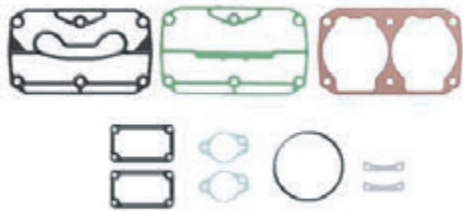

Kompresör Conta Takımı  
Compressor Gasket Kit

110-5004-210



Valf Takımı  
Valve Kit

630-086-101

## FORD

COMPRESSOR APPLICATION	110-5004-000	1835 1838 3235	LK4958
------------------------	--------------	----------------------	--------



Subap Takımı  
Valve Kit

610-086-101

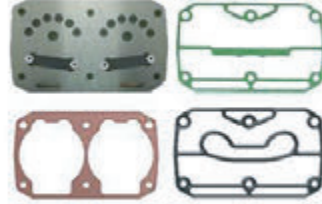

Kompresör Pleyt  
Compressor Plate

570-086-102



Üst Kapak  
Cylinder Head

550-086-102

42549152 - SEB22578



Kompresör Pleyt  
Compressor Plate

560-086-102



Piston

Piston Ø86 mm 2.00 x 2.00 x 3.00 (STD)

230-086-101

Ø86 mm 2.00 x 2.00 x 3.00 (0.25)	230-086-102
Ø86 mm 2.00 x 2.00 x 3.00 (0.50)	230-086-103
Ø86 mm 2.00 x 2.00 x 3.00 (0.75)	230-086-104
Ø86 mm 2.00 x 2.00 x 3.00 (1.00)	230-086-105



Segman

Ring Ø86 mm 2.00 x 2.00 x 3.00 (STD)

231-086-101

Ø86 mm 2.00 x 2.00 x 3.00 (0.25)	231-086-102
Ø86 mm 2.00 x 2.00 x 3.00 (0.50)	231-086-103
Ø86 mm 2.00 x 2.00 x 3.00 (0.75)	231-086-104
Ø86 mm 2.00 x 2.00 x 3.00 (1.00)	231-086-105



Piston & Segman Set

Piston & Ring Set Ø86 mm 2.00 x 2.00 x 3.00 (STD)

233-086-101

42549147-SEB22547-SEB22548	
Ø86 mm 2.00 x 2.00 x 3.00 (0.25) Iveco: 42549148	233-086-102
Ø86 mm 2.00 x 2.00 x 3.00 (0.50)	233-086-103
Ø86 mm 2.00 x 2.00 x 3.00 (0.75)	233-086-104
Ø86 mm 2.00 x 2.00 x 3.00 (1.00)	233-086-105



COMPRESSOR APPLICATION	110-5003-000	3230 -2532 3232 - 3532	LP3974
------------------------	--------------	---------------------------	--------

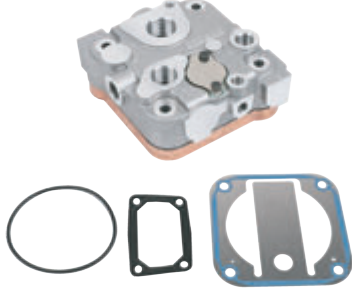

Silindir Kapak Komple  
Cylinder Head Complete

110-5003-050

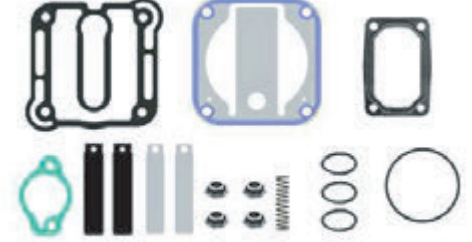

Kompresör Tamir Takımı  
Compressor Repair Kit

110-5003-100

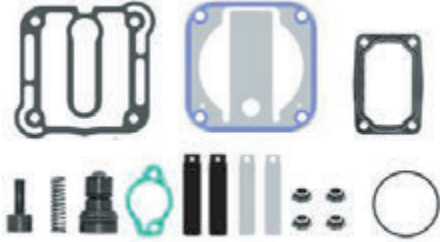

Kompresör Tamir Takımı  
Compressor Repair Kit

51 54100 6049

110-5003-110

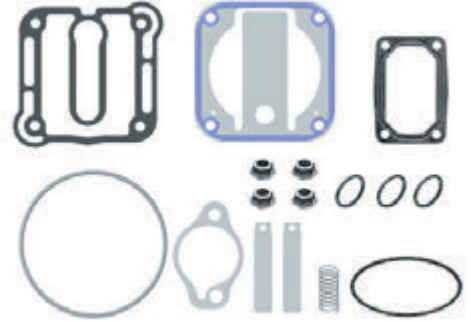

Kompresör Conta Takımı  
Compressor Gasket Kit

110-5003-200

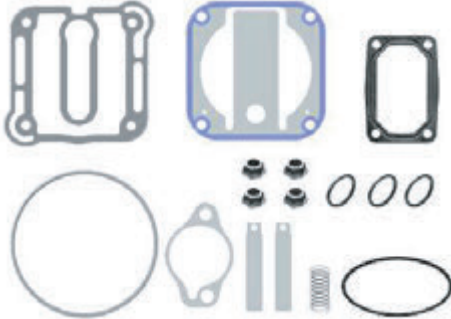

Kompresör Conta Takımı  
Compressor Gasket Kit

110-5003-201

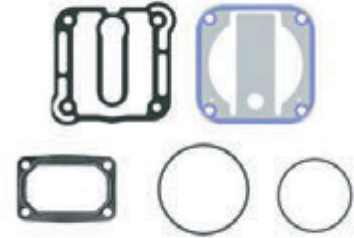

Kompresör Conta Takımı  
Compressor Gasket Kit

110-5003-210



Valf Takımı  
Valve Kit

630-092-101



Subap Takımı  
Valve Kit

610-100-101

## FORD

COMPRESSOR APPLICATION	110-5003-000	3230 -2532 3232 - 3532		LP3974
------------------------	--------------	---------------------------	--	--------

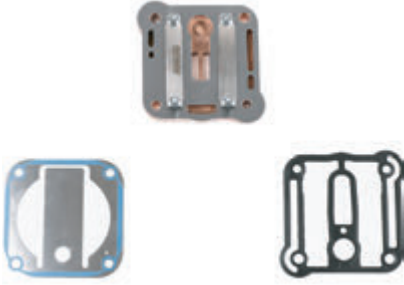

Kompresör Pleyt Tamir  
Compressor Plate Kit

570-092-106

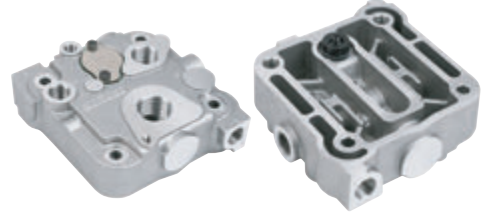

Üst Kapak  
Cylinder Head

550-092-104



Kompresör Pleyt  
Compressor Plate  
51 54124 6003

560-092-102



Piston  
Piston

Ø92 mm 2.50 x 2.50 x 4.00 (STD)

230-092-101

51.54119-6009 - SEB22530-K012079

Ø92 mm 2.50 x 2.50 x 4.00 (0.25)	230-092-102
Ø92 mm 2.50 x 2.50 x 4.00 (0.50)	230-092-103
Ø92 mm 2.50 x 2.50 x 4.00 (0.75)	230-092-104
Ø92 mm 2.50 x 2.50 x 4.00 (1.00)	230-092-105



Segman  
Ring

Ø92 mm 2.50 x 2.50 x 4.00 (STD)

231-092-101

Ø92 mm 2.50 x 2.50 x 4.00 (0.25)	231-092-102
Ø92 mm 2.50 x 2.50 x 4.00 (0.50)	231-092-103
Ø92 mm 2.50 x 2.50 x 4.00 (0.75)	231-092-104
Ø92 mm 2.50 x 2.50 x 4.00 (1.00)	231-092-105



Piston & Segman Set  
Piston & Ring Set

233-092-101

COMPRESSOR APPLICATION	110-5002-000	2524 - 2520 1826 - 2526	LK3848 - LK3854
------------------------	--------------	----------------------------	-----------------

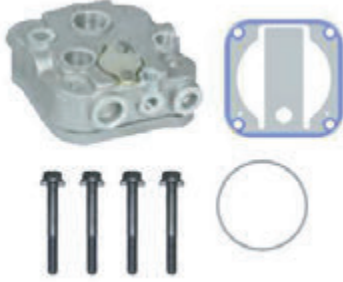

Silindir Kapak Komple  
Cylinder Head Complete

110-5002-050



Kompresör Tamir Takımı  
Compressor Repair Kit

110-5002-100



Kompresör Tamir Takımı  
Compressor Repair Kit  
SEB22519

110-5002-110



Kompresör Conta Takımı  
Compressor Gasket Kit

110-5002-200



Kompresör Conta Takımı  
Compressor Gasket Kit

110-5002-201

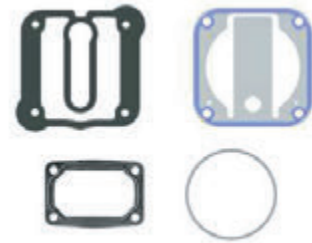

Kompresör Conta Takımı  
Compressor Gasket Kit

110-5002-210



Valf Takımı  
Valve Kit

630-080-101



Subap Takımı  
Valve Kit

610-080-101



## FORD

COMPRESSOR APPLICATION	110-5002-000	2524 - 2520 1826 - 2526		LK3848 - LK3854
------------------------	--------------	----------------------------	--	-----------------



Kompresör Pleyt Tamir  
Compressor Plate Kit

570-080-102



Üst Kapak  
Cylinder Head

550-080-102



Kompresör Pleyt  
Compressor Plate

560-080-102



Piston  
Piston

Ø80 mm 2.50 x 2.50 x 4.00 (STD)

230-080-101

Ø80 mm 2.50 x 2.50 x 3.00 (0.25)	230-080-102
Ø80 mm 2.50 x 2.50 x 3.00 (0.50)	230-080-103
Ø80 mm 2.50 x 2.50 x 3.00 (0.75)	230-080-104
Ø80 mm 2.50 x 2.50 x 3.00 (1.00)	230-080-105



Segman  
Ring

Ø80 mm 2.50 x 2.50 x 4.00 (STD)

231-080-101

Ø80 mm 2.50 x 2.50 x 4.00 (0.25)	231-080-102
Ø80 mm 2.50 x 2.50 x 4.00 (0.50)	231-080-103
Ø80 mm 2.50 x 2.50 x 4.00 (0.75)	231-080-104
Ø80 mm 2.50 x 2.50 x 4.00 (1.00)	231-080-105



Piston & Segman Set

Piston & Ring Set Ø80 mm 2.50 x 2.50 x 4.00 (STD)

233-080-101

SEB22517	
Ø80 mm 2.50 x 2.50 x 4.00 (0.25)	233-080-102
Ø80 mm 2.50 x 2.50 x 4.00 (0.50)	233-080-103
Ø80 mm 2.50 x 2.50 x 4.00 (0.75)	233-080-104
Ø80 mm 2.50 x 2.50 x 4.00 (1.00)	233-080-105

COMPRESSOR APPLICATION	110-5001-000	CARGO 3227	LK3965 - 1180656
------------------------	--------------	------------	------------------

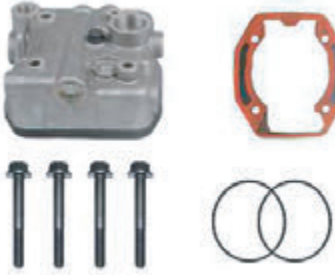

Silindir Kapak Komple  
Cylinder Head Complete

110-5001-050



Kompresör Tamir Takımı  
Compressor Repair Kit

110-5001-090



Kompresör Tamir Takımı  
Compressor Repair Kit

110-5001-100



Kompresör Conta Takımı  
Compressor Gasket Kit  
1699826

110-5001-200



Kompresör Conta Takımı  
Compressor Gasket Kit

110-5001-210



Valf Takımı  
Valve Kit  
3091592

630-088-104



Kompresör Pleyt Tamir  
Compressor Plate Kit  
1699825

570-088-107



Üst Kapak  
Cylinder Head  
1699825

550-088-114

## FORD

COMPRESSOR APPLICATION	110-5001-000	CARGO 3227		LK3965 - 1180656
------------------------	--------------	------------	--	------------------



Kompresör Pleyt  
Compressor Plate

560-088-107



Silindir Gömlek Set (Hava Soğutmalı)  
Cylinder Liner Set (Air Cooled)

234-088-131



Piston  
Piston

Ø88 mm 2.50 x 2.50 x 4.00 (STD)

230-088-101

Ø88 mm 2.50 x 2.50 x 4.00 (0.25)	230-088-102
Ø88 mm 2.50 x 2.50 x 4.00 (0.50)	230-088-103
Ø88 mm 2.50 x 2.50 x 4.00 (0.75)	230-088-104
Ø88 mm 2.50 x 2.50 x 4.00 (1.00)	230-088-105



Segman  
Ring

Ø88 mm 2.50 x 2.50 x 4.00 (STD)

231-088-101

85100626-3097153-II39526F0061	
Ø88 mm 2.50 x 2.50 x 4.00 (0.25)	231-088-102
Ø88 mm 2.50 x 2.50 x 4.00 (0.50)	231-088-103
Ø88 mm 2.50 x 2.50 x 4.00 (0.75)	231-088-104
Ø88 mm 2.50 x 2.50 x 4.00 (1.00)	231-088-105



Piston & Segman Set

Piston & Ring Set Ø88 mm 2.50 x 2.50 x 4.00 (STD)

233-088-101

SEB22555-85101375-3095841-1698848	
Ø88 mm 2.50 x 2.50 x 4.00 (0.25)	233-088-102
Ø88 mm 2.50 x 2.50 x 4.00 (0.50)	233-088-103
Ø88 mm 2.50 x 2.50 x 4.00 (0.75)	233-088-104
Ø88 mm 2.50 x 2.50 x 4.00 (1.00)	233-088-105



Silindir Gömlek (Hava Soğutmalı)  
Cylinder Liner (Air Cooled)

232-088-101



COMPRESSOR APPLICATION	110-5000-000	CARGO 2520		KZ 930
------------------------	--------------	------------	--	--------

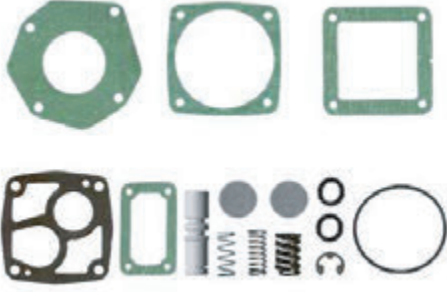

Kompresör Tamir Takımı  
Compressor Repair Kit

110-5000-100

## FORD

COMPRESSOR APPLICATION	110-5000-000	CARGO 2520		KZ 930
------------------------	--------------	------------	--	--------



# AIR BRAKE SYSTEMS

grower.com.tr



**GROWER**<sup>®</sup>  
Air Brake Systems

🏠 Büsan Organize Sanayi Bölgesi 10641 Sk No:7 Karatay - KONYA / TURKEY

☎ +90 332 345 05 84

📠 +90 332 345 05 86

✉ info@grower.com.tr

🌐 www.grower.com.tr

